

**Hello,
I've arrived!**

Now that I'm here you are only one
flat-pack away from transforming
your home.

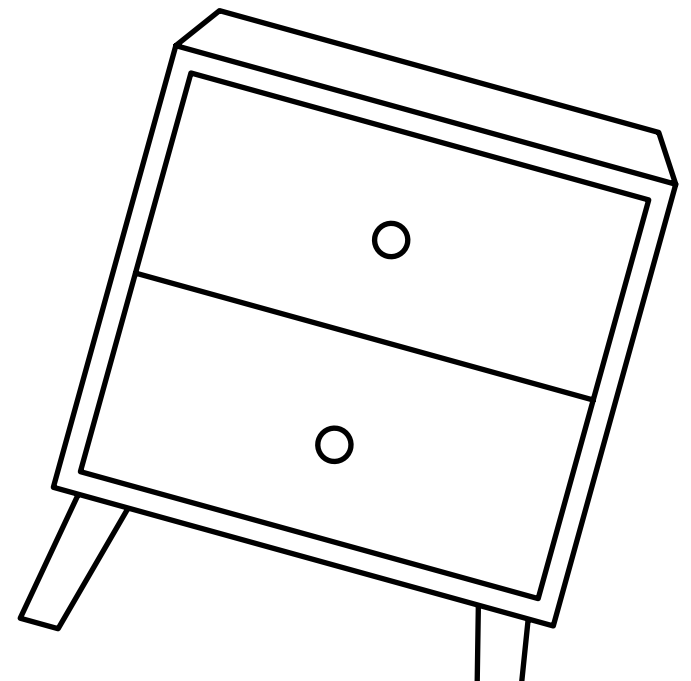
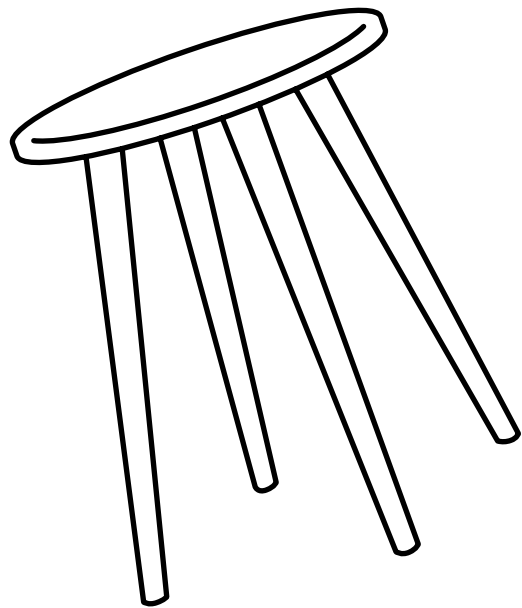

Mocka.

Thank you for supporting us.

We believe design belongs to everyone. From materials and processes to safety testing, production and delivery, we are passionate and committed to bringing you the best possible product so you can create beautifully functional spaces to feel comfortably you.

Here are a few assembly tips before you get started:



Make Time

The first step to all seamless assembly is taking a moment to carefully read through the instructions—you are already on your way to creating a beautifully functional space!



Set The Mood

Put on your favourite playlist, order that pizza and pour yourself a drink to get in the mood!



Tool Check

Layout the instructions, screws and panels to check you have everything you need. A blanket or soft floor rug will help protect your new favourite item from scratches and a drill will speed up the assembly too!



Room Reveal

You did it! Take a step back and enjoy the moment. Don't forget to recycle any packaging and share a pic of your room reveal—we love seeing how you transform your home! **Tag us @mockaaustralia/@mockaanz**

Happy flat-packing!

the Mocka Team

Need help? Our Support Team are available via live chat, email or phone. Visit our website for details.

AUSTRALIA

+61 7 3184 8466

Our phone lines are available weekdays 9am to 5pm AEST



NEW ZEALAND

+64 3 384 1858

Our phone lines are available weekdays 9am to 5pm NZT

Felix Teddy Occasional Chair

Thank you for purchasing Felix Teddy Occasional Chair. Please follow the manufacturer's assembly instructions in detail.

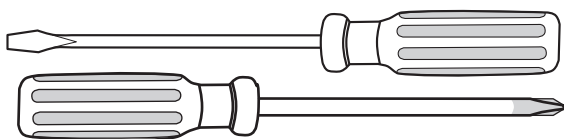
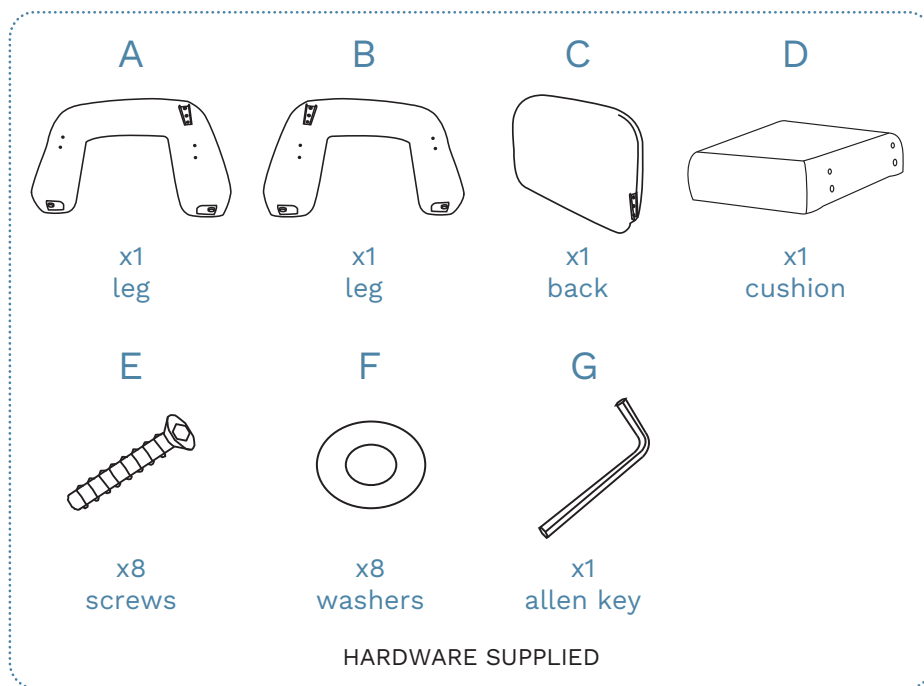

Phillips & Flathead screwdrivers required.

For quicker assembly, we recommend the use of a power drill on a low-speed setting.

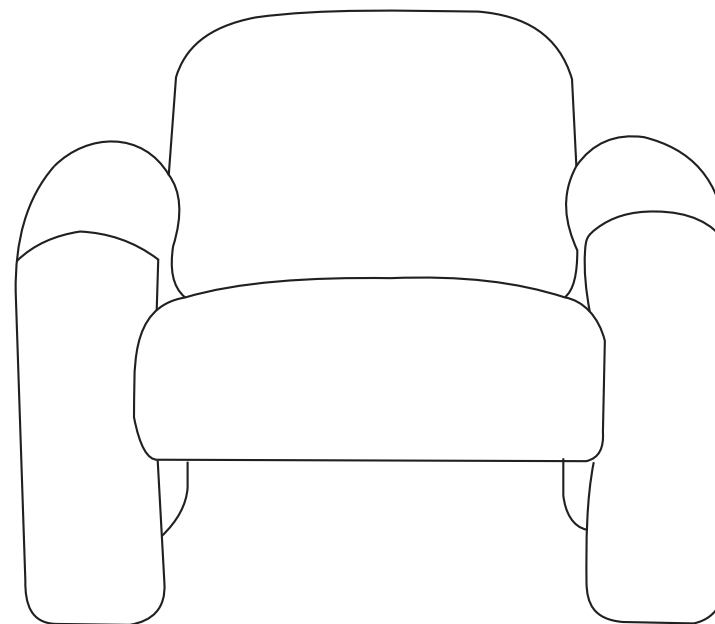

Felix Teddy Occasional Chair

1

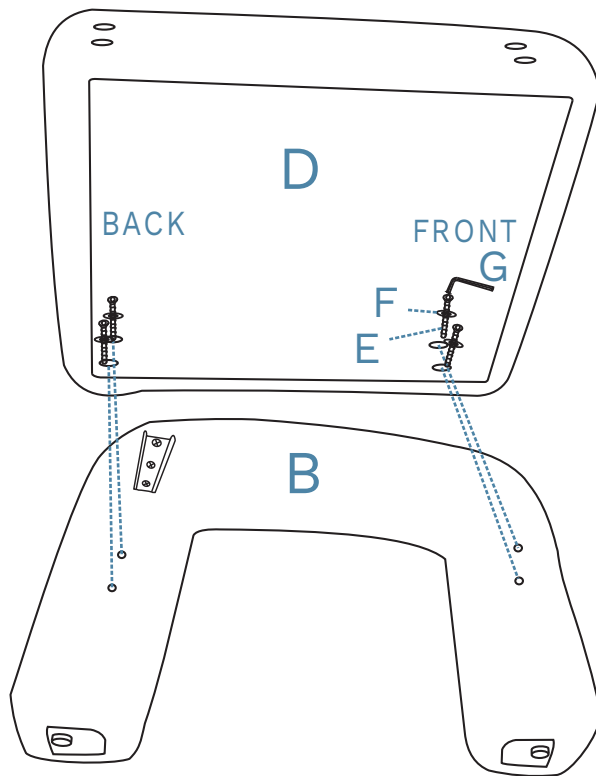

Attach 1 x cushion (D) to 1 x leg (B) and secure with 4 x screws (E) and 4 x washers (F). Tighten with an Allen Key (G).

2

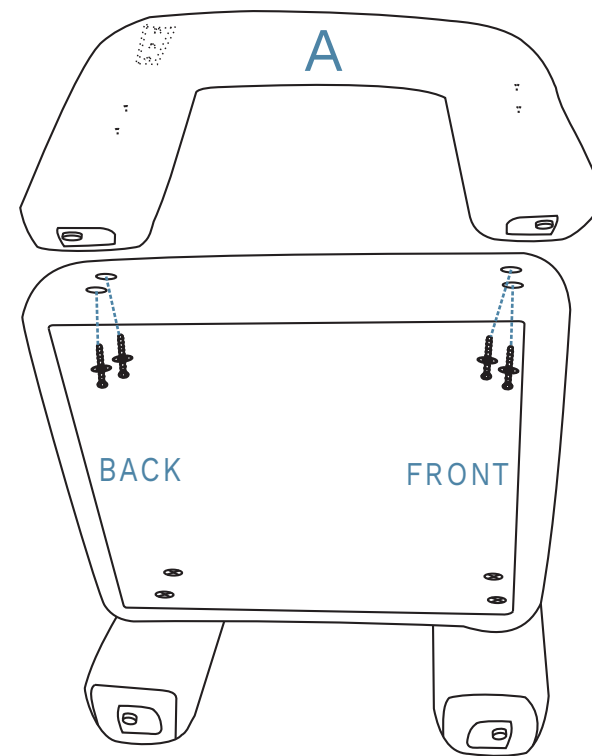

Attach 1 x leg (A) to assembled frame as shown and secure with 4 x screws (E) and 4 x washers (F). Tighten with an Allen Key (G).

Felix Teddy Occasional Chair

3

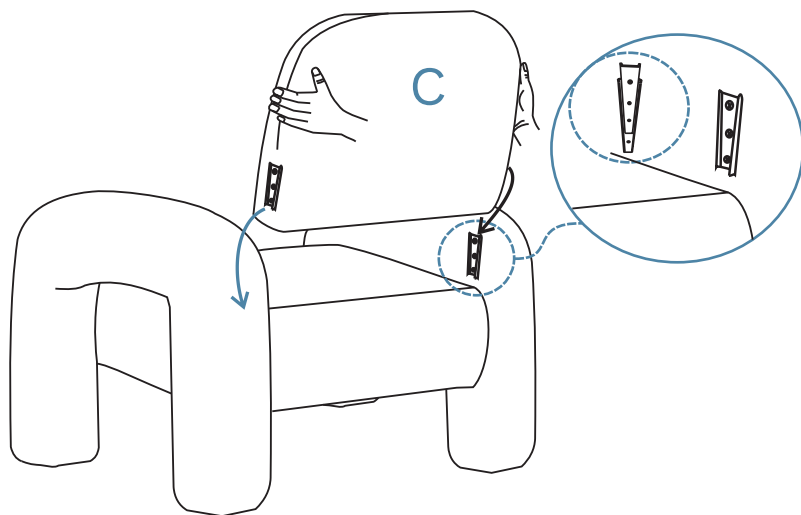

Attach 1 x cushion (C) into position as shown.

4

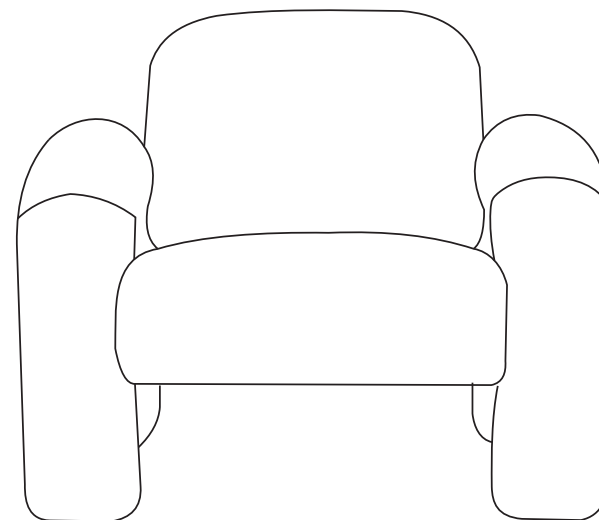

Once assembled lift furniture into place, do not drag. Ensure unit is balanced and steady before use. You're done, enjoy!



Love it for longer.

Spot clean only with a clean, damp, undyed cloth. Remove all liquid and food spills immediately. Protect from direct sunlight and heat. Do not use abrasives or common household detergents.



Caring for our world.

In the interest of our environment, please dispose of all packaging thoughtfully.



Good news, you're all done!

Love it and share it on Instagram by tagging

 [@mockaaustralia](#) | [@mockanz](#)